

GATE MAINTENANCE

To clean, rinse with lukewarm water, wash gently with mild soap or detergent and lukewarm water, using a soft cloth or sponge. Rinse again. Dry with a soft cloth or sponge to prevent water spotting. DO NOT SCRUB or use brushes or squeegees.

GATE CARE & REMINDERS

At **CARDINAL GATES, INC.**, we design what we believe to be the very best, and most user friendly gates available. Our gates are built to last many years with proper use and care. Here are a few suggestions...

- Close gates gently - do not slam - to prevent damage to latch mechanism.
- When closing, be sure safety bracket on gate frame engages as depicted in instructions.
- Children should not be allowed to swing on an open gate as this can damage hinge mount.
- Keep allen wrench in a secure place. We suggest removing set screws when separating sections for cleaning. Periodically check all screws, bolts, etc. for security and proper adjustment.

CARDINAL GATES, INC., offers many accessories such as extensions, stair kits, and other safety products. Check with your dealer or call **CARDINAL GATES, INC.** at 770-252-4200.

We sincerely hope that you thoroughly enjoy many years of service from your **CARDINAL GATE**.

GATE WARRANTY

Your Cardinal Gates product is warranted to be free of manufacturer's defects for a period of one (1) year from the date of purchase when used in homes, and according to manufacturers instructions. When used commercially, the warranty is 90 days. Only products purchased through Authorized Resellers are eligible for warranty claims. Products purchased used are not eligible for warranty claims

Cardinal Gates, Inc. will either repair or replace, at our option, any parts necessary to correct defects in material or workmanship during the warranty period. The warranty disclaims liability for incidental, special and consequential damages of any nature.

To exercise warranty, please contact us at: customerservice@cardinalgates.com.

You must include the following:

- Proof of Purchase / Order Confirmation / Receipt
- Brief note describing problem with the product and image of damage / defect
- Full shipping address along with phone number

FOR
MAXIMUM
SAFETY,
ALWAYS KEEP
GATE LATCHED
AND CLOSED.

FOR FURTHER ASSISTANCE
Call 770-252-4200

CARDINAL GATES
SAFETY PRODUCTS FOR CHILDREN, PETS & HOMES

79 Amlajack Way
Newnan, GA 30265
www.cardinalgates.com

ALWAYS
DISCONTINUE
USE IF GATE
BECOMES
DAMAGED,
BROKEN OR
DISASSEMBLED.

STAIRWAY SPECIAL - MODEL SS30

PARTS LIST FOR INSTALLATION

JAN 2026

GATE IS RECOMMENDED FOR CHILDREN BETWEEN 6 AND 24 MONTHS.
IF INSTALLING AT TOP OF STAIRS, INSTALL A MINIMUM OF THREE INCHES FROM END OF FIRST STEP.

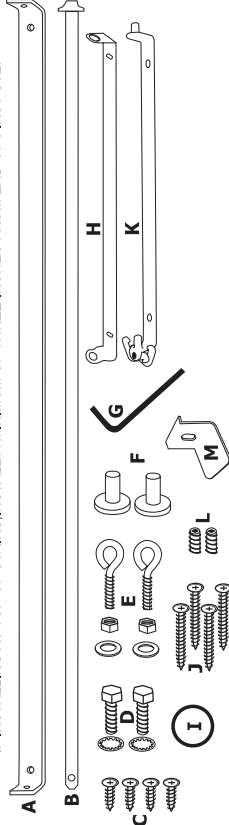

TOOLS NEEDED

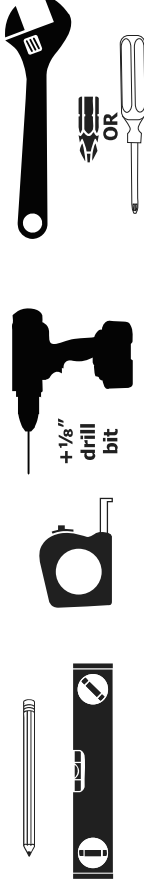

READ BEFORE INSTALLATION

Gate should be installed directly into wood or into studs behind drywall. Some installs will have neither available. In this case, you must use drywall anchors. **DO NOT use screws into drywall.** Drywall will not hold the installed gate. We recommend the following type of 75+ lbs.-rated drywall anchors (not included).

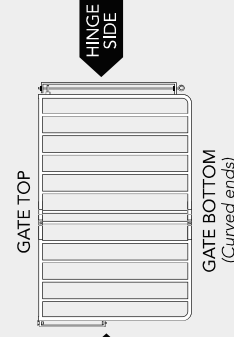
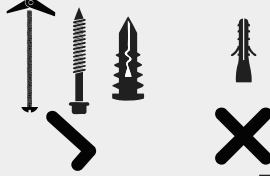

EXTENSIONS AVAILABLE:

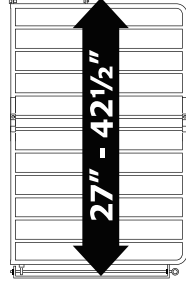

INSTALL VIDEO:



WARNING

Children have died or been seriously injured when gates are not securely installed.
• ALWAYS install and use gates as directed using all required parts. • NEVER use to keep child away from pool.
• STOP using when a child can climb over or dislodge the gate. • Use only with the latching mechanism securely engaged.

STAIRWAY SPECIAL - MODEL SS30 GATE INSTALLATION

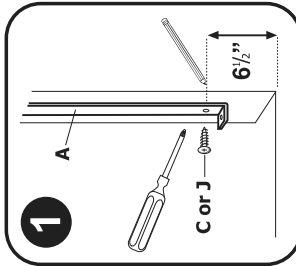

STEP ONE:
Mark with pencil 6 1/2" above floor surface. Drill 1/8" pilot hole. Install hinge bracket (A) to wall using Phillips screw (C or J).

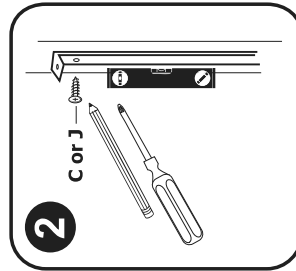

STEP TWO:
Straighten and level bracket to mark hole. Drill 1/8" pilot hole. Screw (C) in top of hinge bracket securing it to the wall.

*NOTE: ALTERNATE PARTS MIGHT BE NEEDED FOR ABOVE STEPS FOR PASTER, DRYWALL, BRICK, ETC.

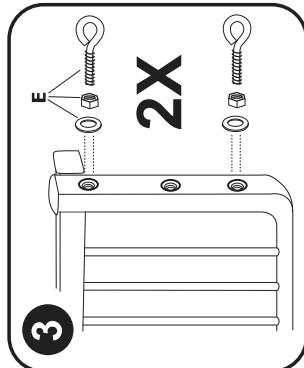

STEP THREE:
Screw nuts onto eye bolts as far as they will go. Insert eye bolts with washer (E) into top and bottom of hinge side gate (three hole side).

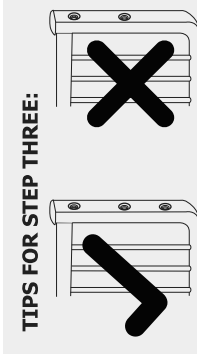

TIPS FOR STEP THREE:

Thread both eye bolts into the gate the same distance. Different lengths could impair proper gate function. Rod in next step needs to be parallel to the wall.

DO NOT OVERTIGHTEN EYE BOLTS!
HAND-TIGHTEN ONLY. You can break eye bolt or pull out rivet nut by using excessive force.

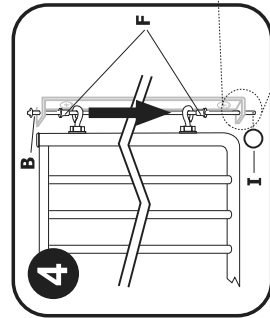
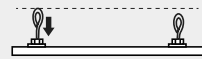

STEP FOUR:
Hang gate by inserting hinge rod (B), through top of mounted hinge bracket (A), through upper plastic shoulder washer (F), through both eye bolts, through lower plastic shoulder washers (F), and finally through bottom of hinge bracket. To secure hinge, insert key ring (I) through hole in end of hinge rod.

FOR PROPER GATE OPERATION AND SECURITY, THE KEY RING MUST BE INSTALLED. To temporarily remove gate, remove ring, slide hinge rod up and out. Retain ring and shoulder washers for re-installation.

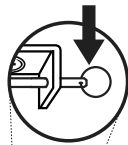

BEST CONFIGURATION FOR STORAGE:

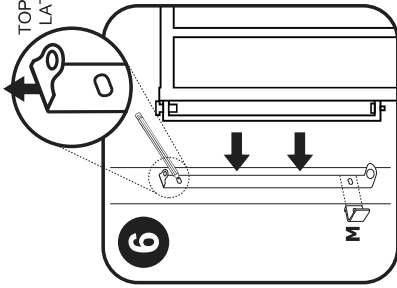

STEP FIVE:
Mount latch assembly (K) to gate using 3/4" bolts with serrated washers (D). Attach wall mount for latch assembly (H) up into part (K) that is now secure on gate.

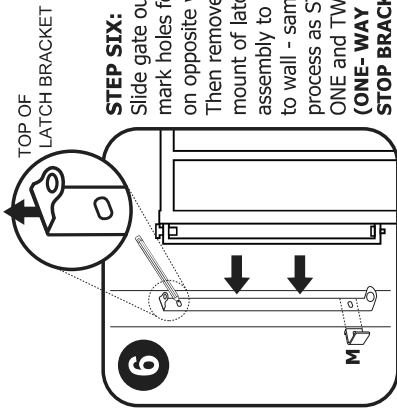

STEP SIX:
Slide gate out to mark holes for (H) on opposite wall. Then remove wall mount of latch assembly to attach to wall - same process as STEPS ONE and TWO. (ONE-WAY STOP BRACKET INSTALLED HERE)

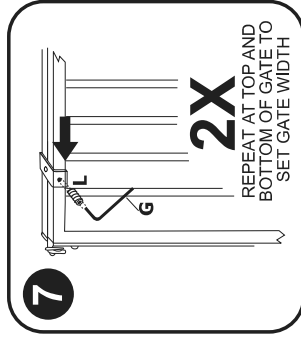

STEP SEVEN:
With gate closed and latched, use Allen wrench (G) to insert set screws (L) in the upper and lower brackets of the gate. Tighten the set screws to set the width of the gate.

TIPS FOR STEP SIX:
*Gate can be installed at up to a 30-degree angle if you have to locate a stud behind drywall.

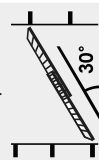

ONE-WAY STOP BRACKET IS RECOMMENDED FOR TOP OF STAIR USE to set door to only open AWAY from stairs.

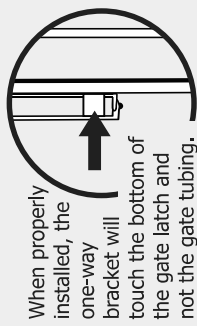

When properly installed, the one-way bracket will touch the bottom of the gate latch and not the gate tubing.



TIPS FOR STEP SEVEN:
Gate brackets will have an open, threaded hole on one side for set screws.

DO NOT SEPARATE GATE PANELS. Scan QR code for video to fix.



GATE OPERATION

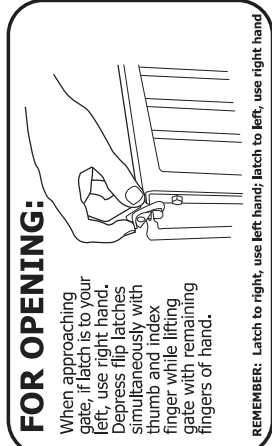

FOR CLOSING:

Grasp gate in middle. Lift gate and align latch pins with bracket holes. Drop in place. There is no need to close gate using flip latches.

FOR OPENING:

When approaching gate, if latch is to your left, use right hand. Depress flip latches simultaneously with thumb and index finger while lifting gate with remaining fingers of hand.

REMEMBER: Latch to right, use left hand; latch to left, use right hand